

FT-4 A-A剖面 1:50

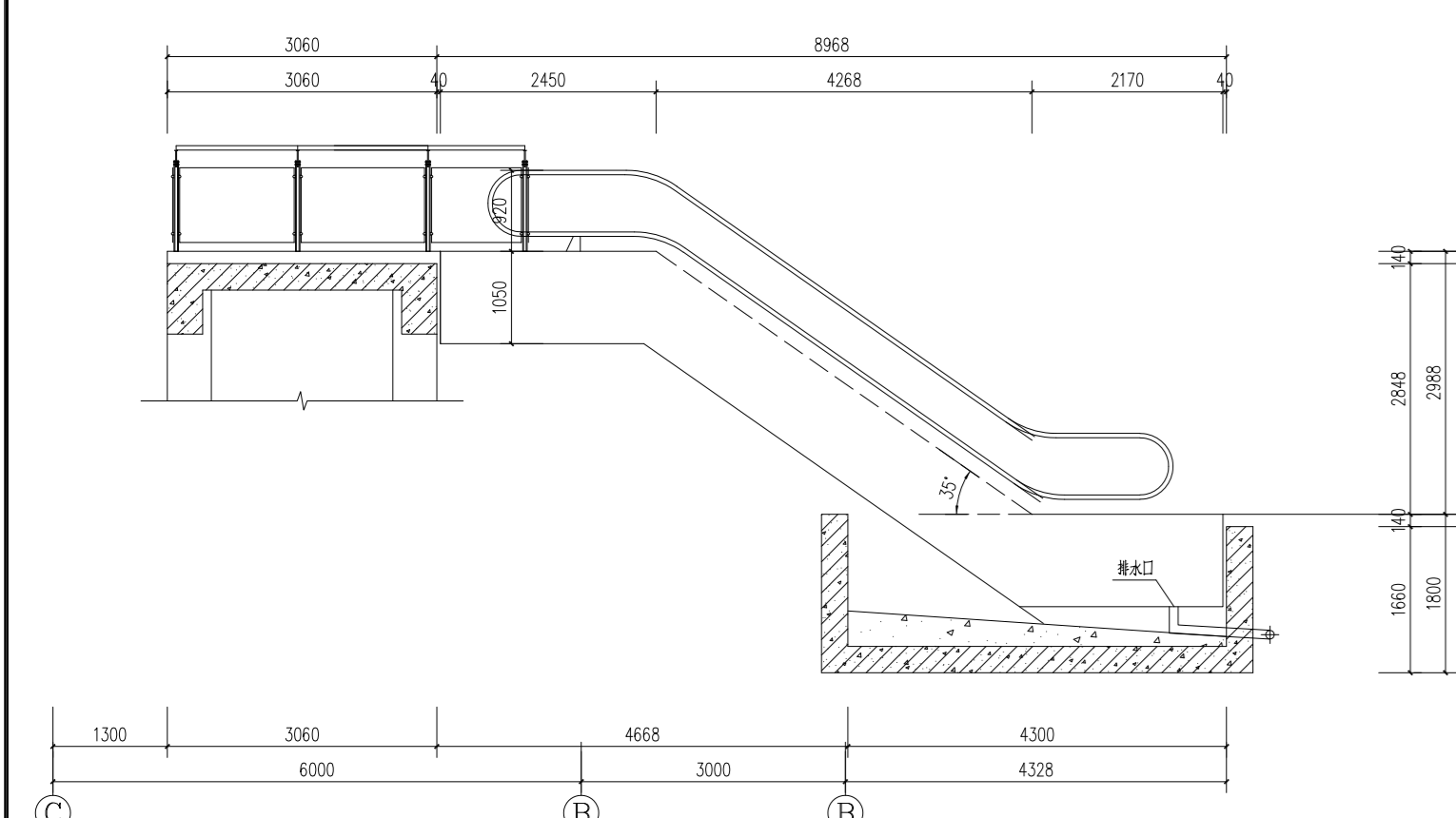

FT-4 B-B剖面 1:50

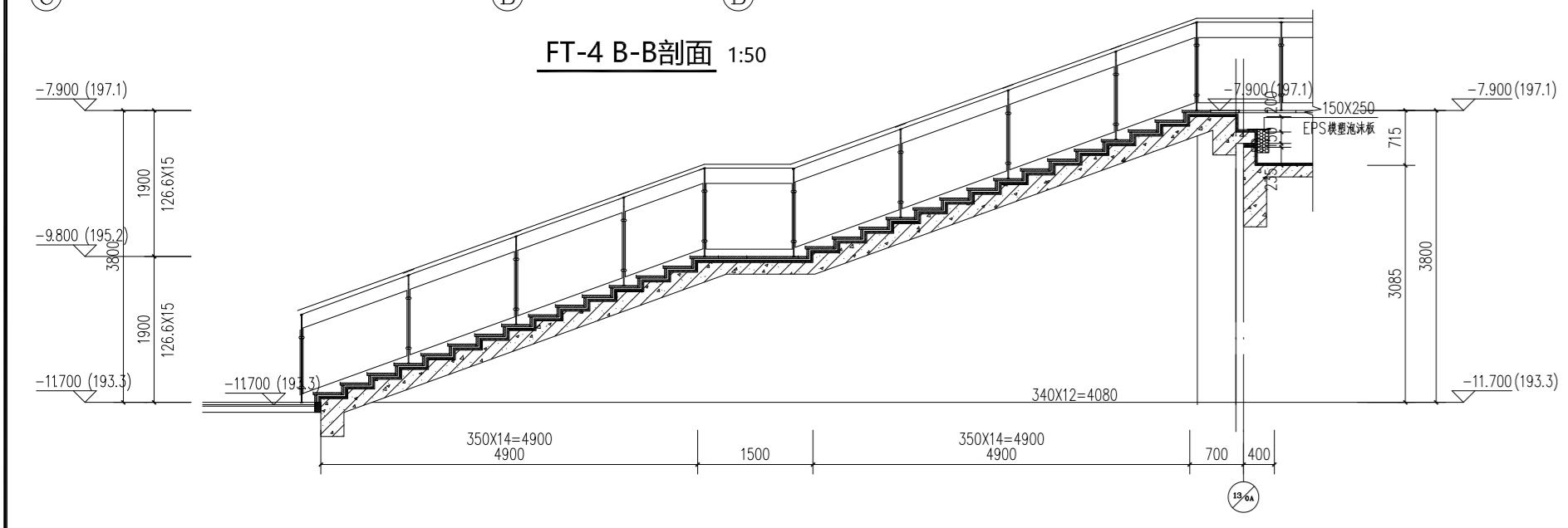

TB-1 F-F剖面 1:50

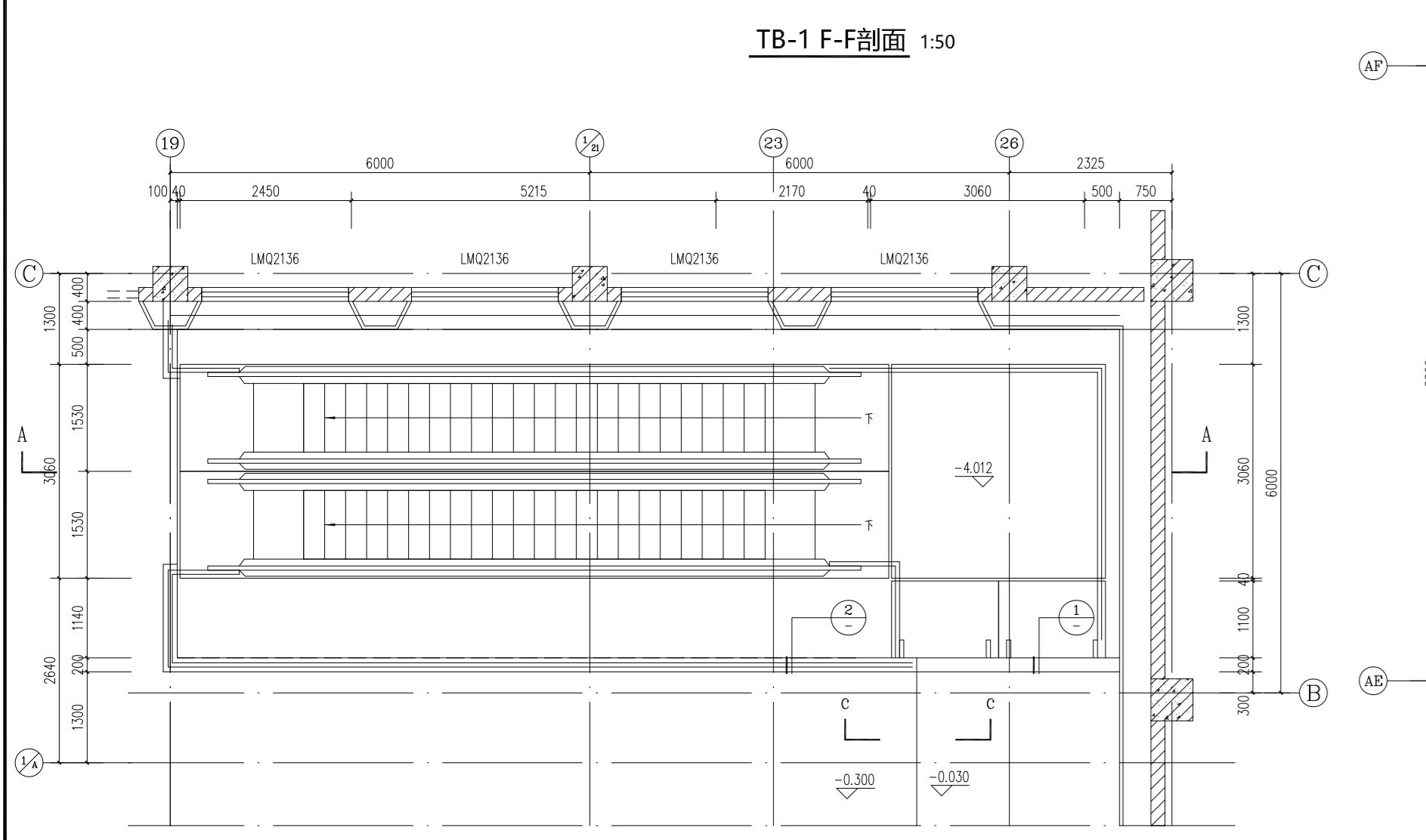

FT-4 ±0.000标高平面 1:50

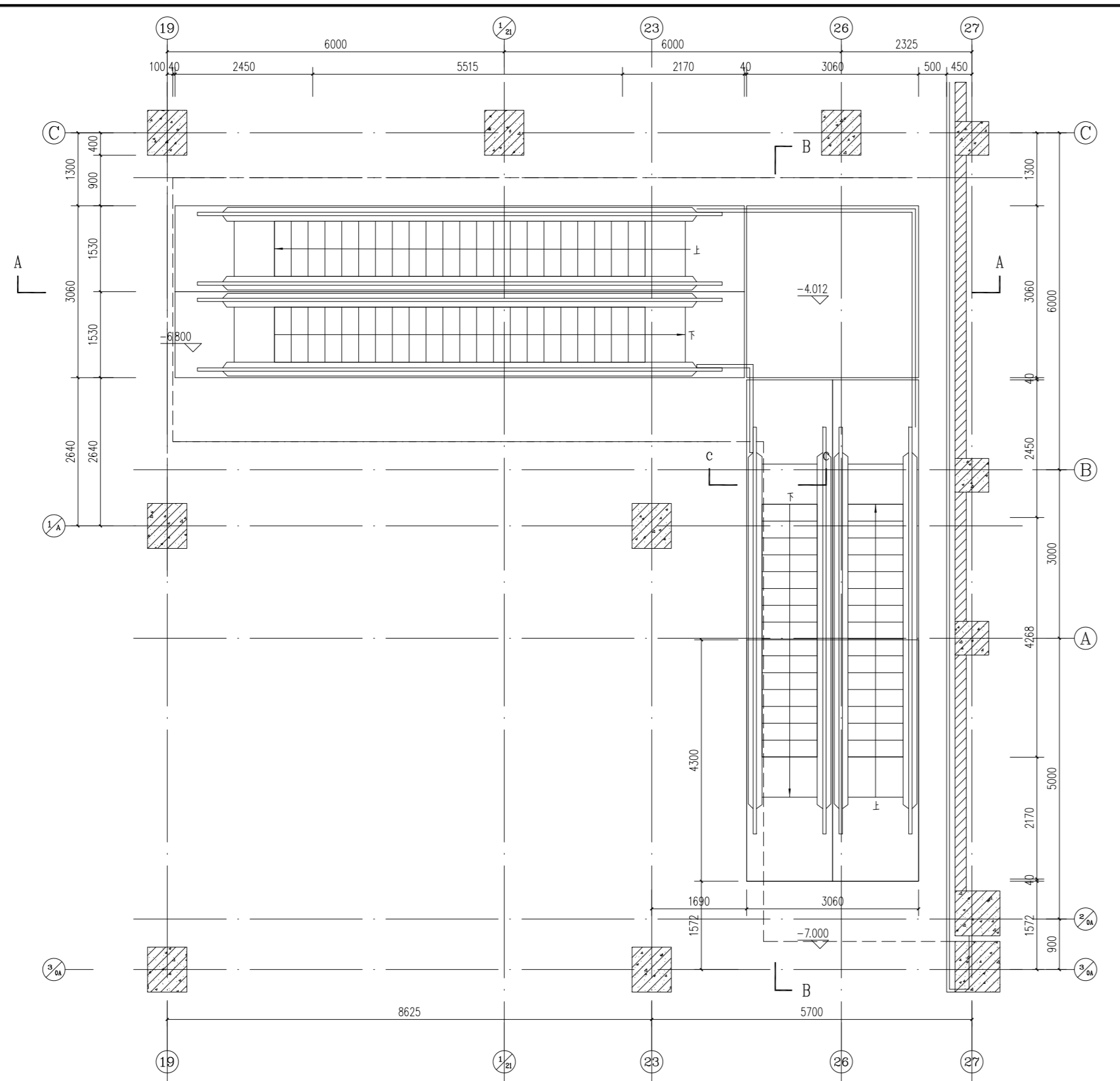

FT-4 -3.8标高平面 1:50

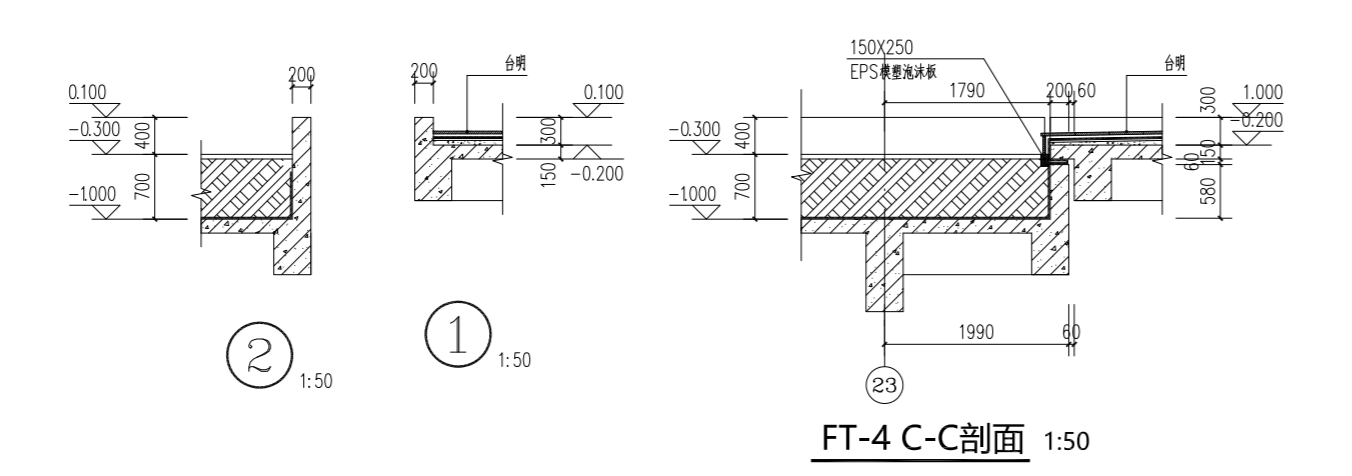

FT-4 C-C剖面 1:50

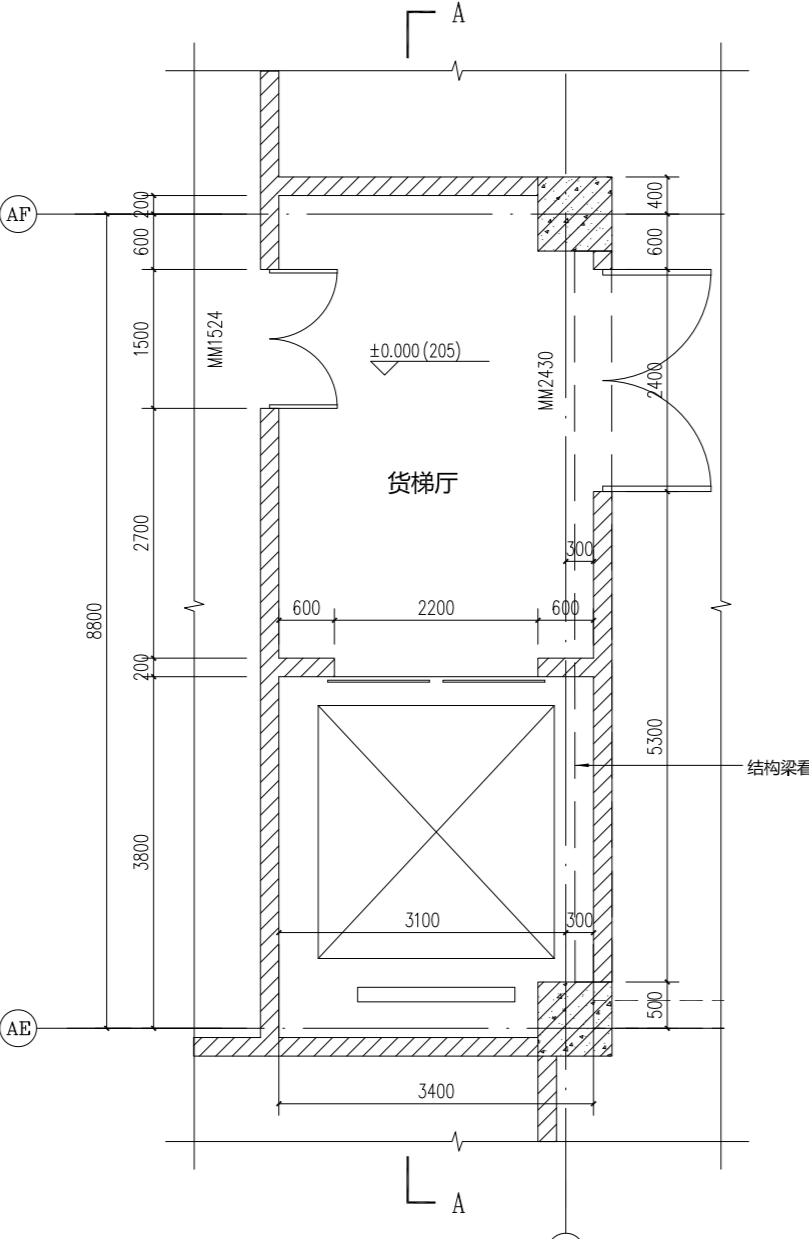

HT-2 ±0.000标高平面 1:50

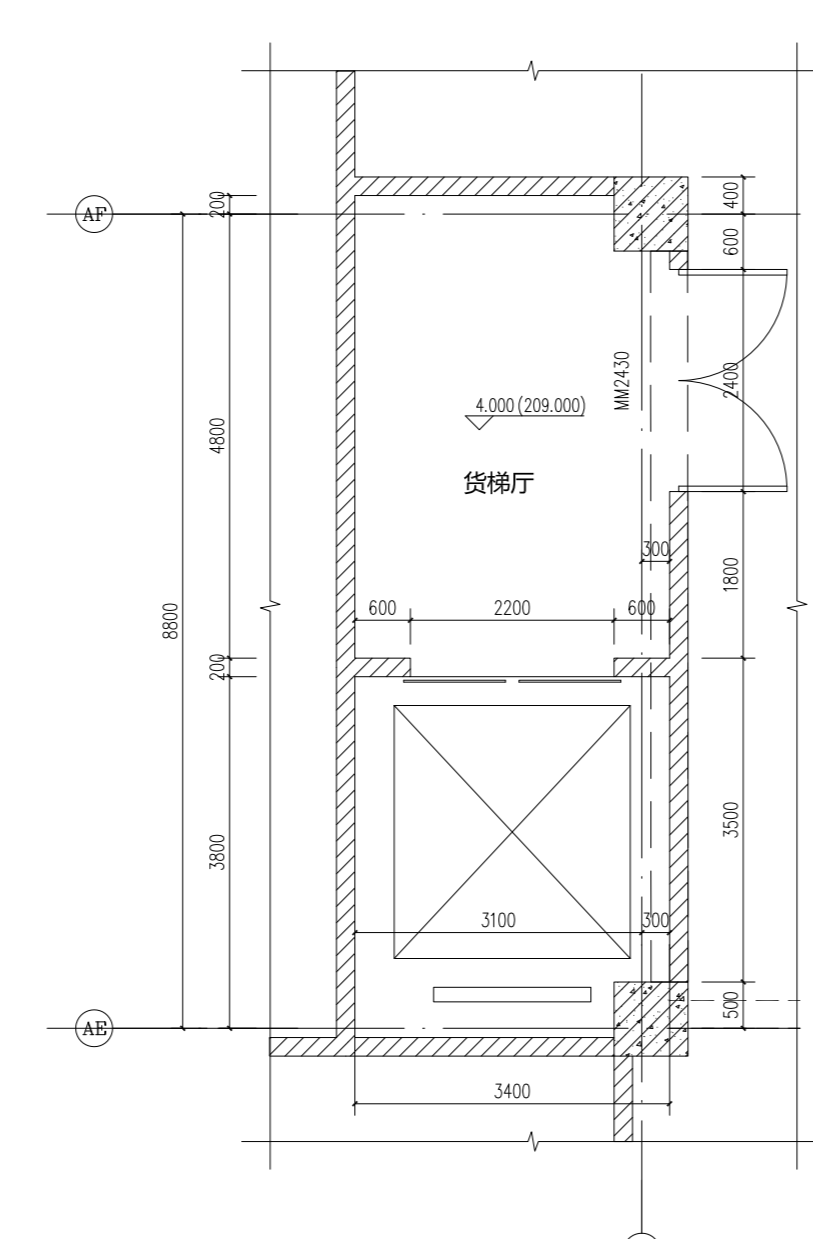

HT-2 -4.000标高平面 1:50

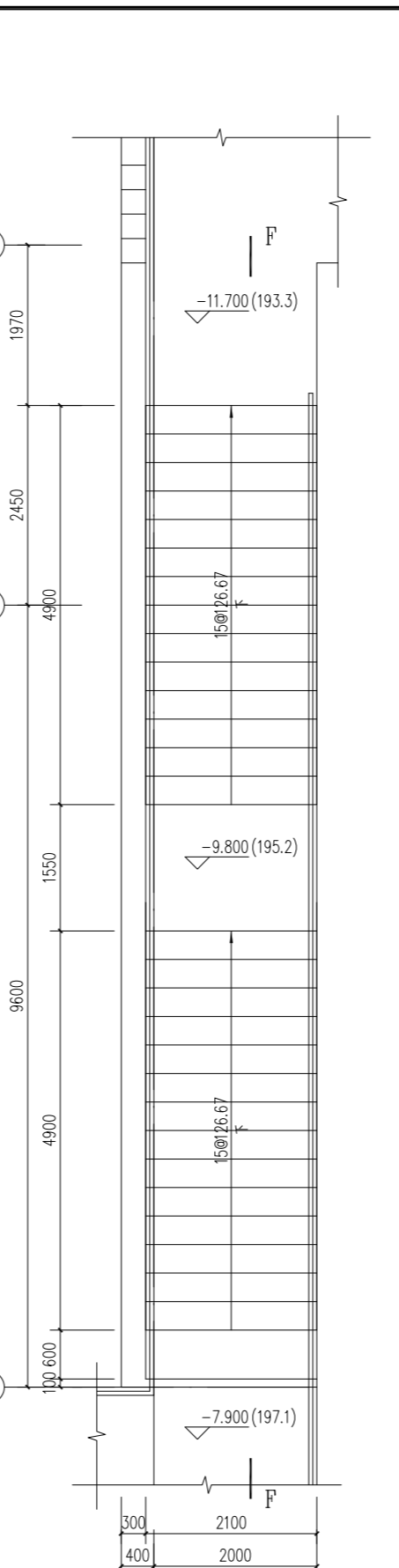

TB-1 放大平面 1:50

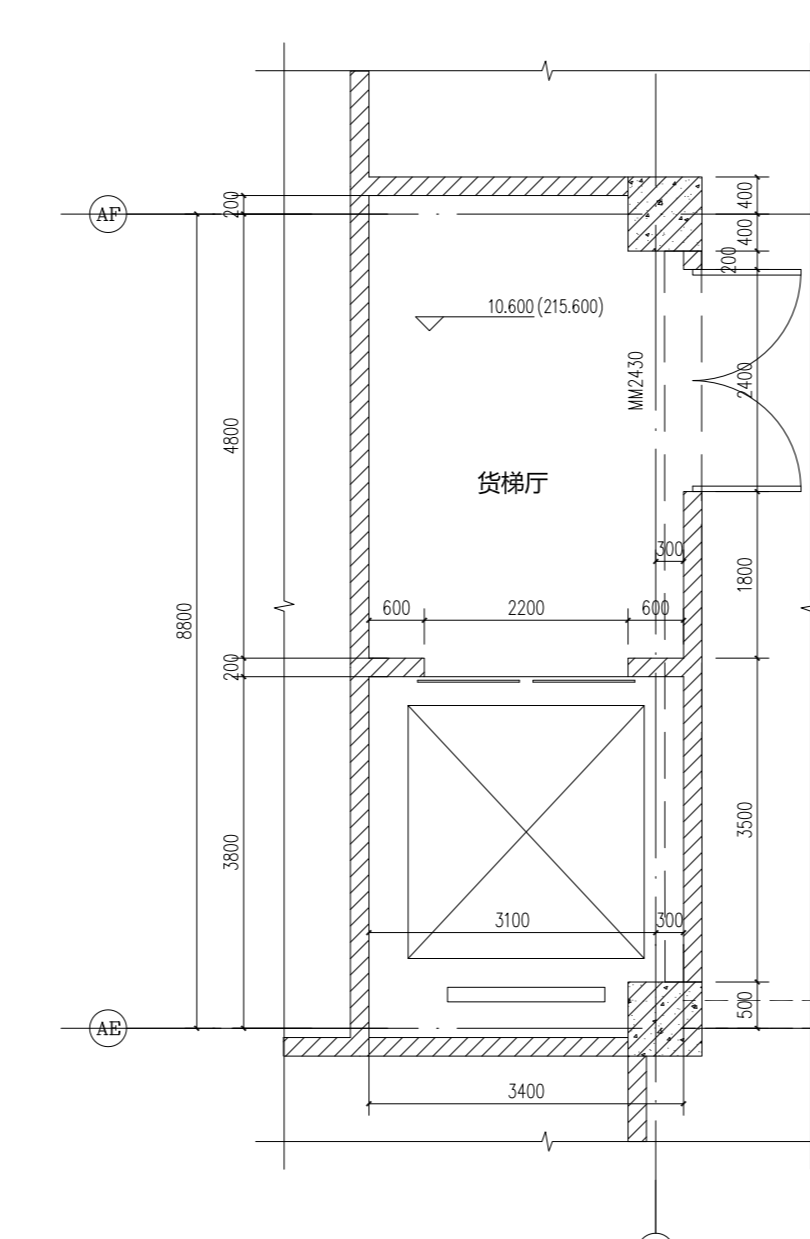

HT-2 -10.000标高平面 1:50

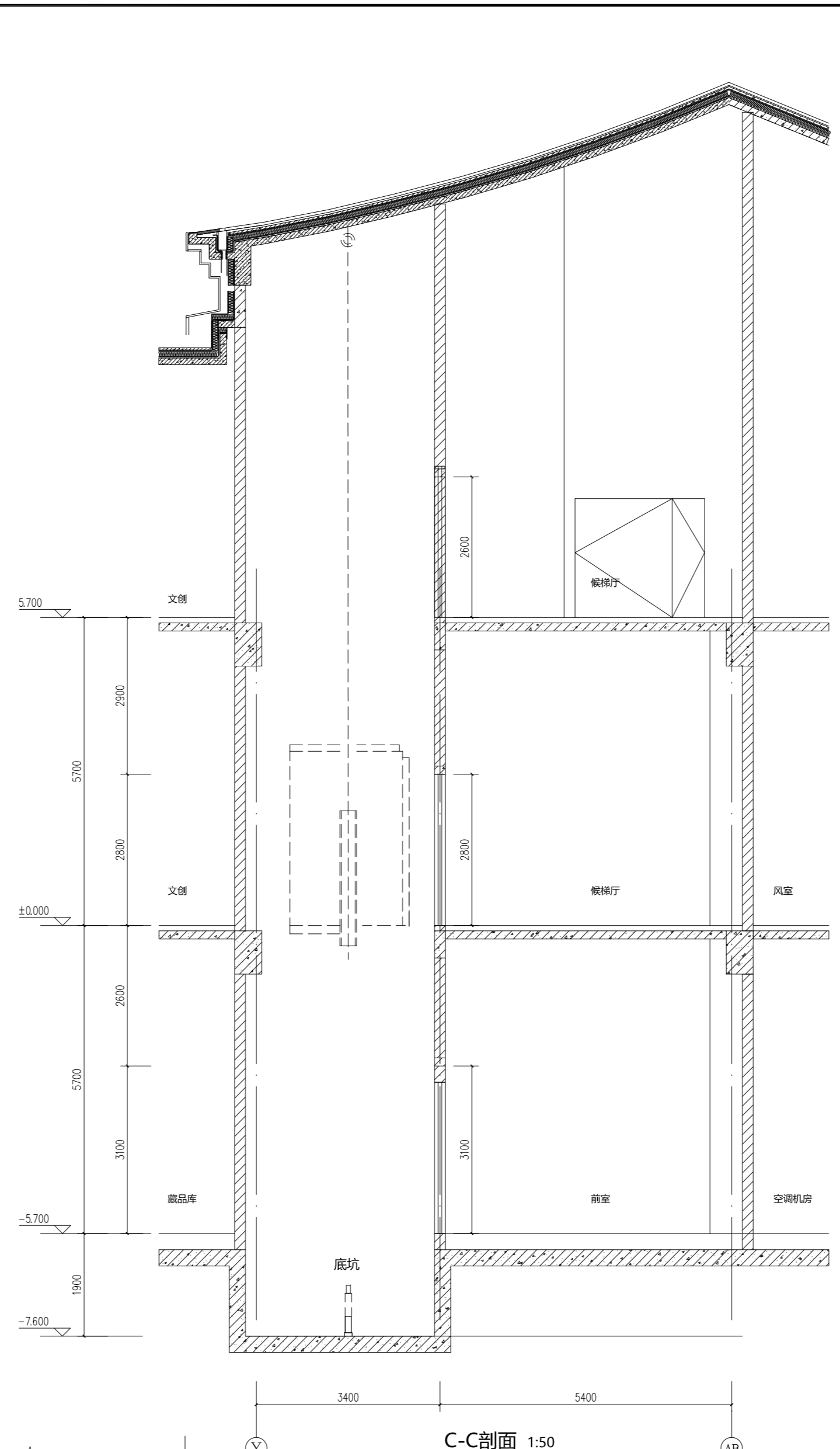

C-C剖面 1:50

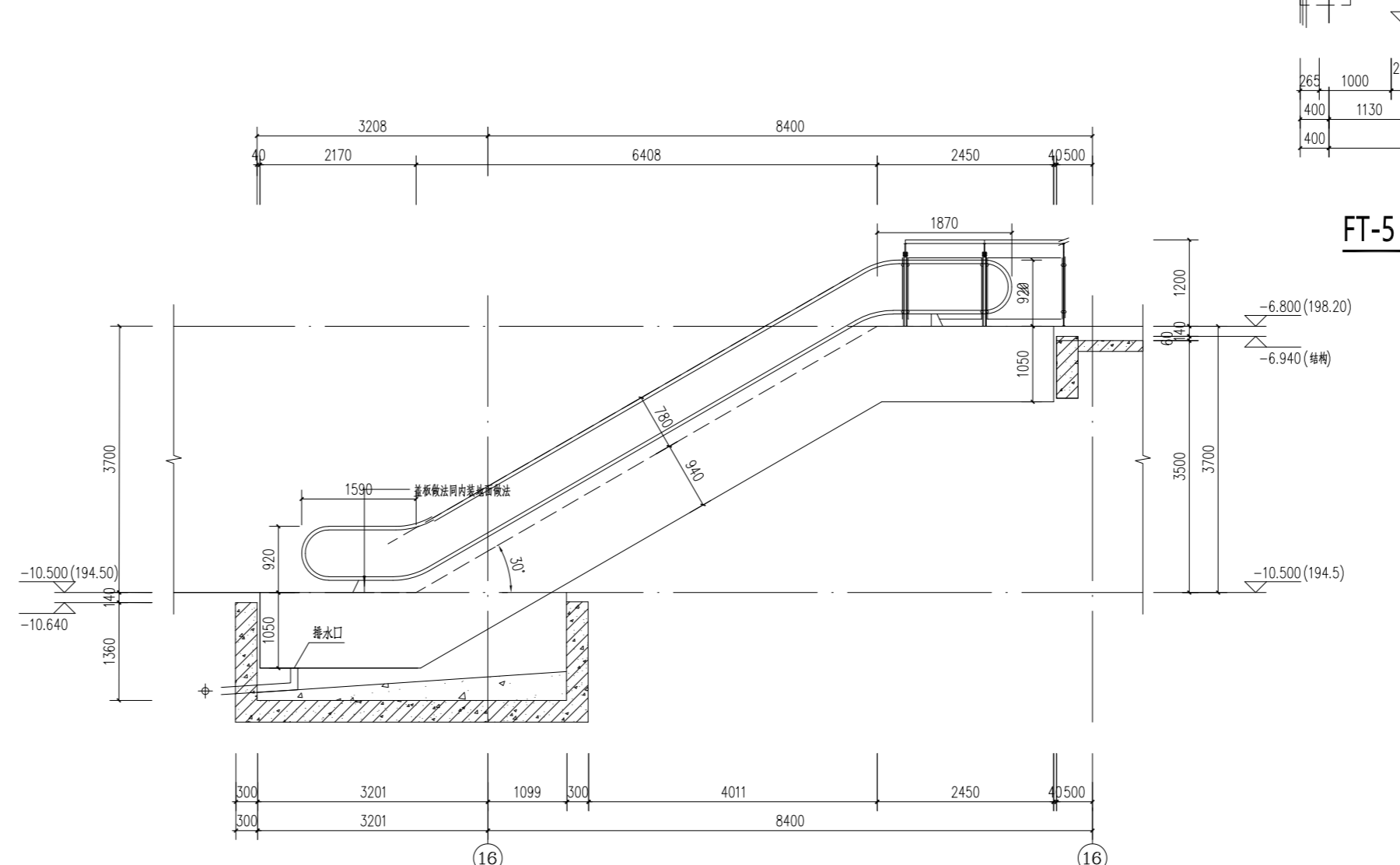

FT-5 D-D剖面 1:50

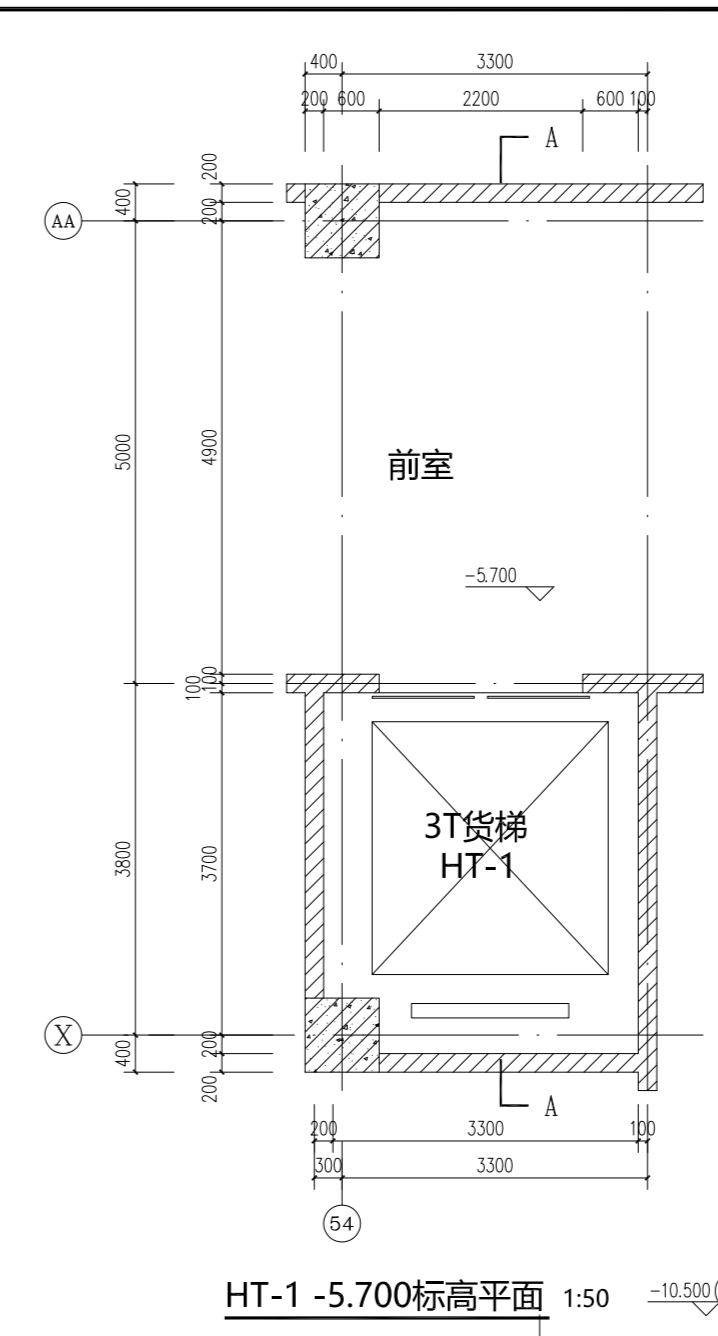

HT-1 -5.700标高平面 1:50

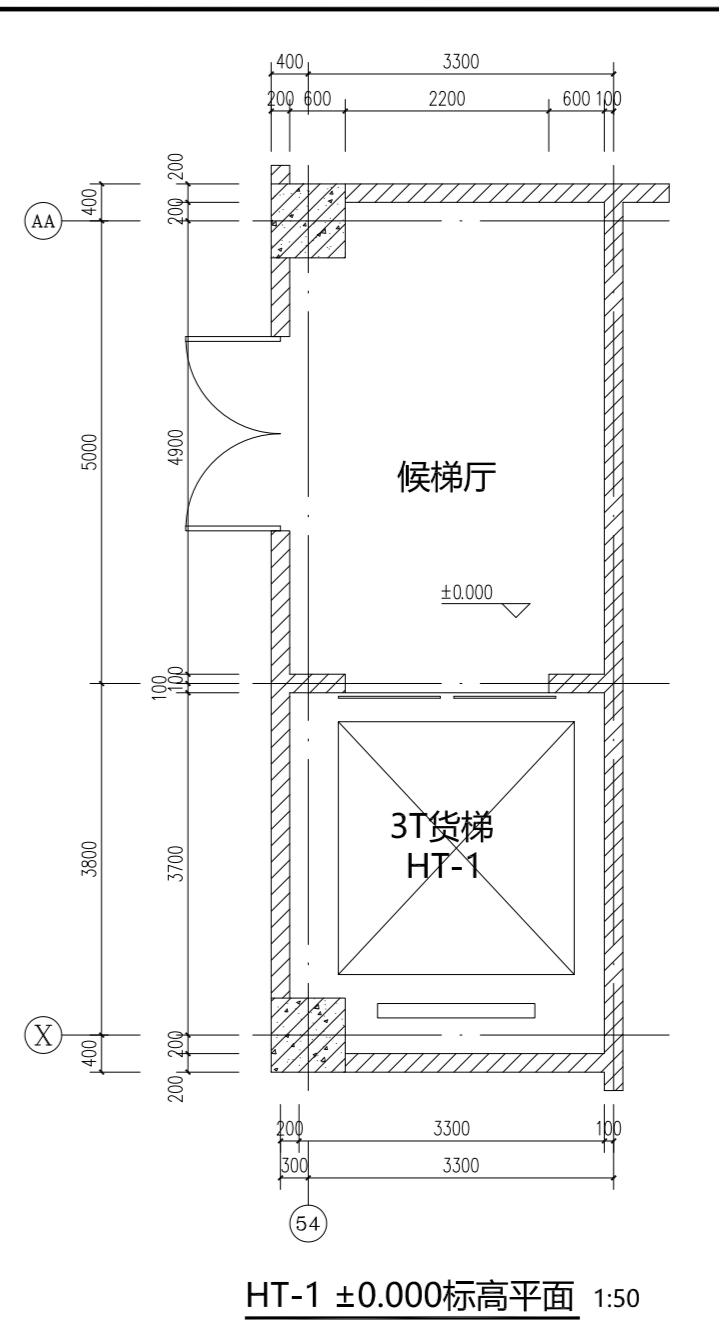

HT-1 ±0.000标高平面 1:50

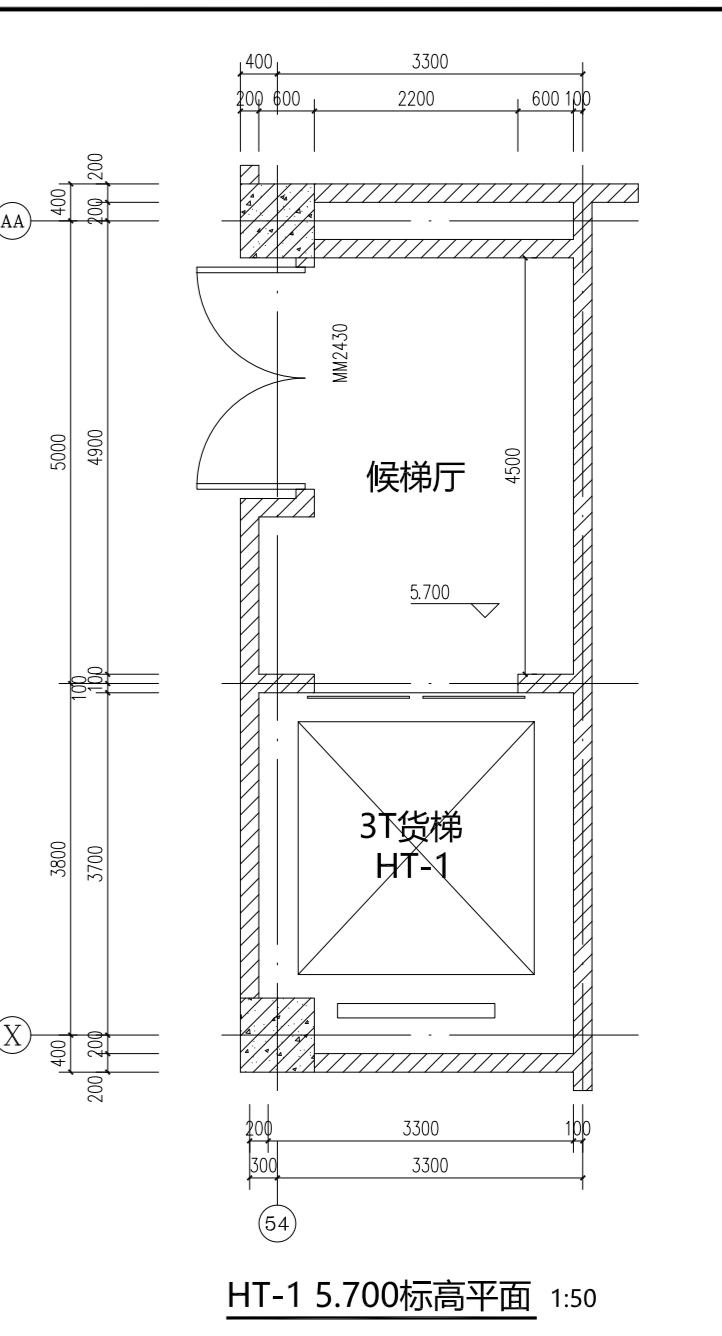

HT-1 5.700标高平面 1:50

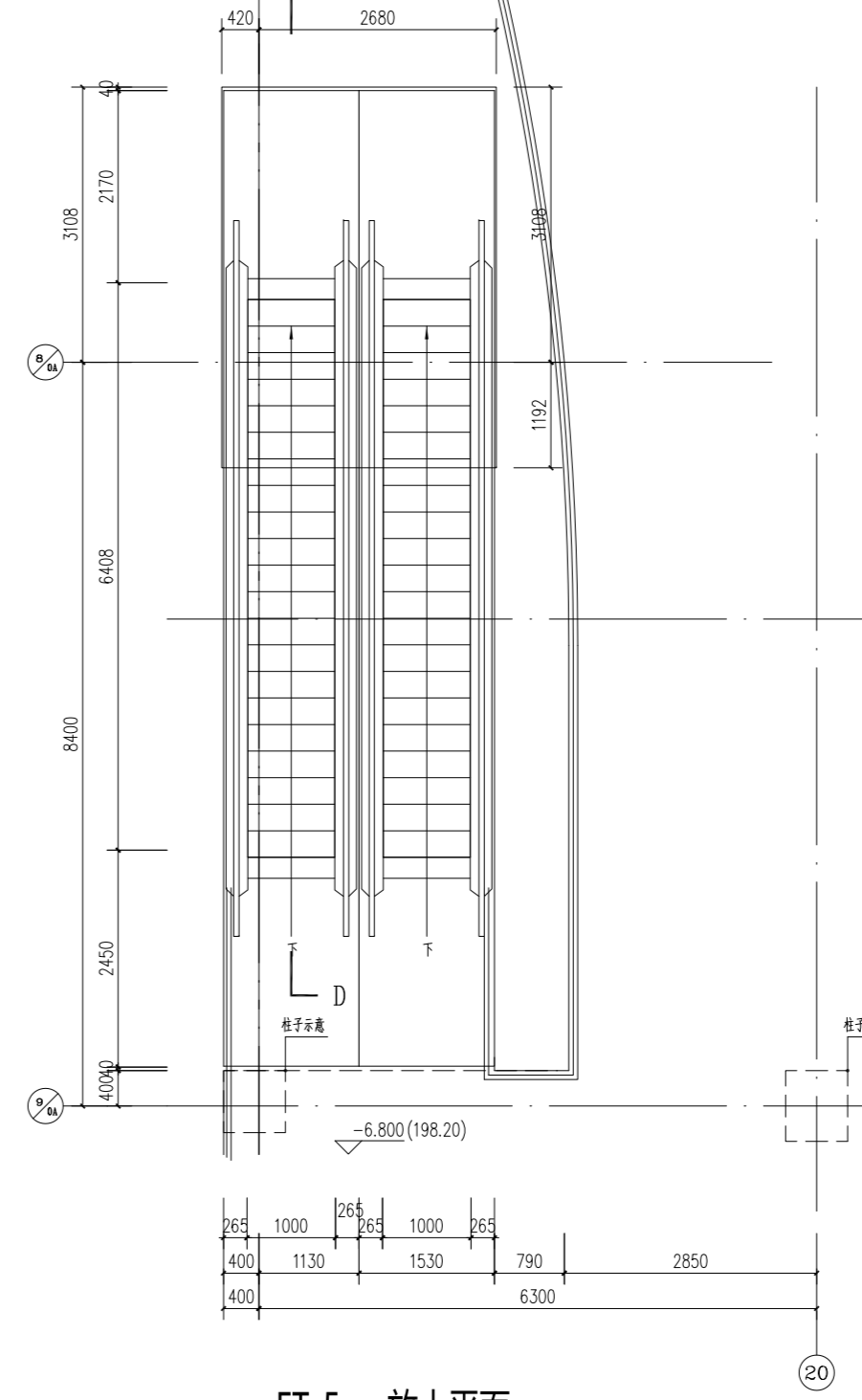

FT-5 放大平面 1:50

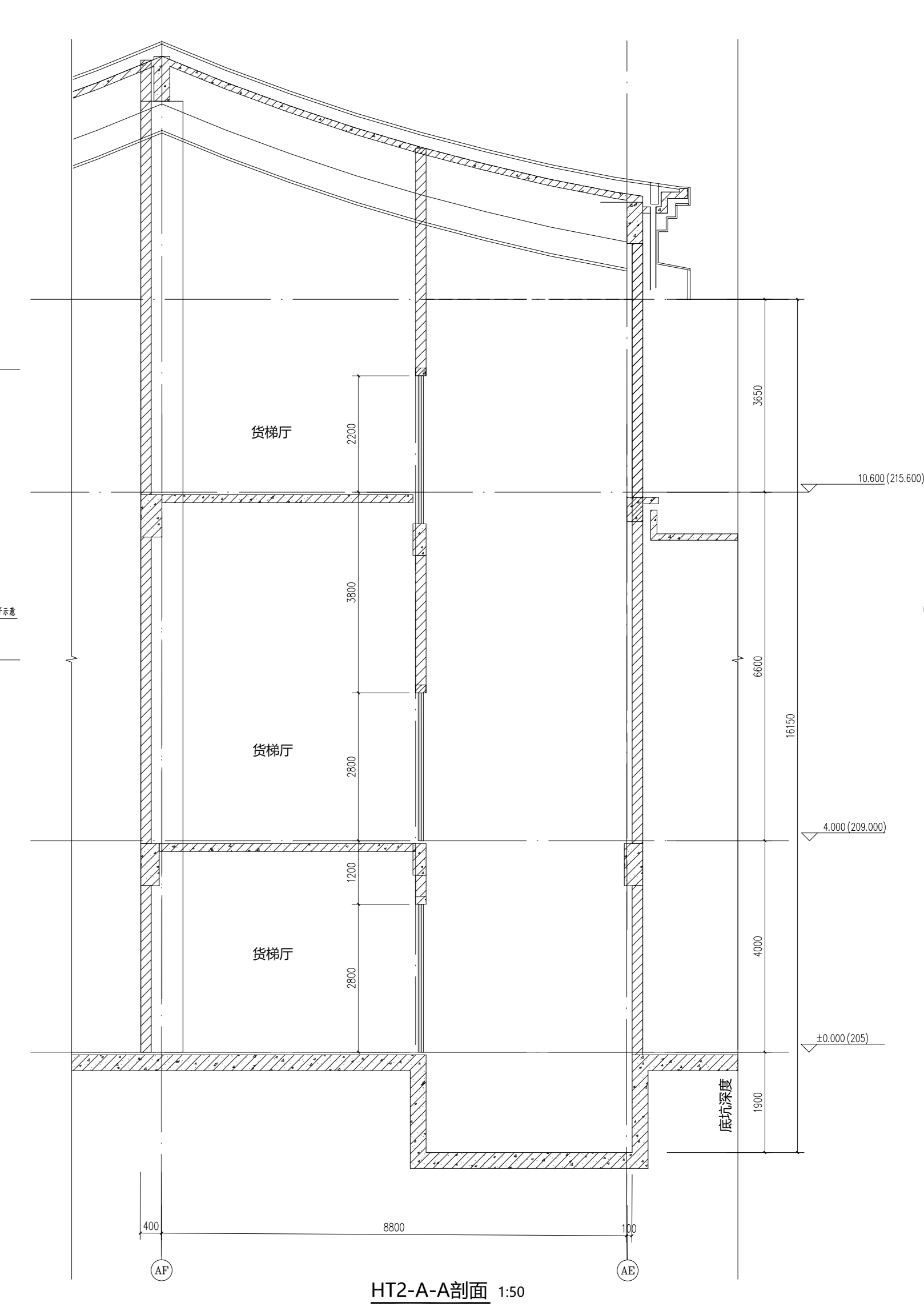

HT2-A-A剖面 1:50

设计单位 设计人 审核人 日期	项目名称 18610986 6100263-145
设计说明 1. 本工程为... 2. 本工程... 3. 本工程...	
设计人 审核人 日期	设计人 审核人 日期